



**Order No. 2.14700
Hut Combination 47**

Safety distance 
 Device dimensions 
 Functional distance 

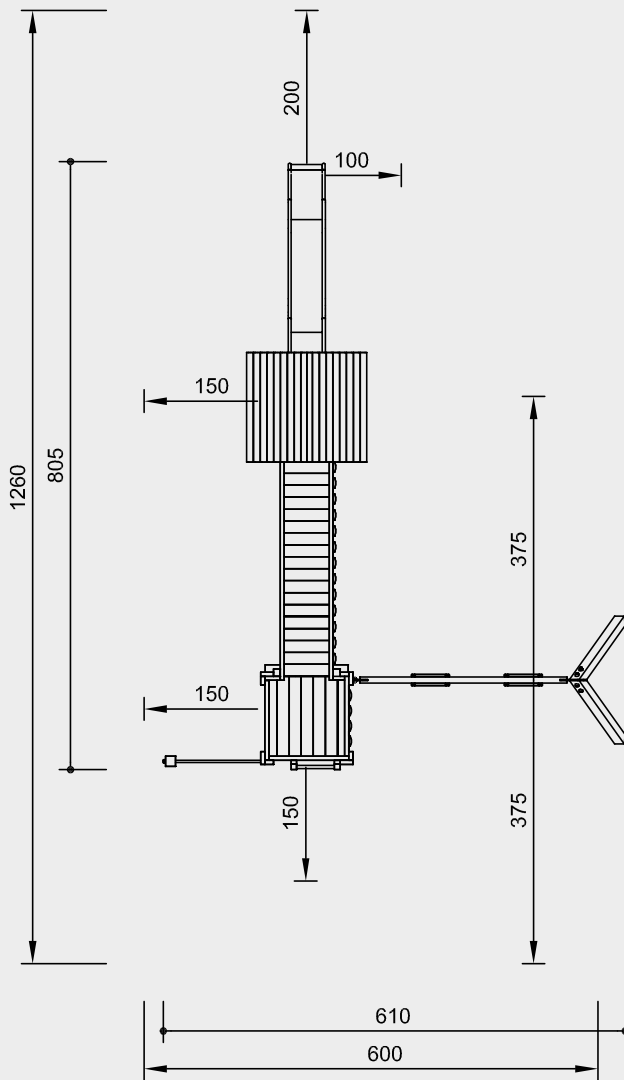

Scale 1:100

Safety check according to DIN EN 1176

**Order No. 2.14700
Hut Combination 47**

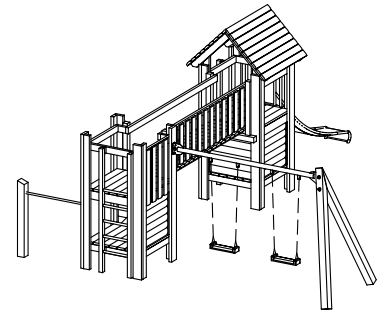



Components

Order No.

- | | |
|--|-----------------|
| 1 Platform Hut with steel feet | 3.13100 |
| 1 Platform Hut with roof with steel feet | 3.13300 |
| 1 Stainless Steel Slide | 3.19210 |
| 1 Bridge 3.00 m | 3.66310 |
| 1 Balustrade 3.00 m | w/o No. |
| 2 Support Frames for Bridge | 3.66364 |
| 1 Horizontal Bar with steel foot | L3.69700 |
| 1 Double Swing special with steel feet | 3.19020 |



Order No. L2.18000
Tower Combination 18 made of larch

Safety distance 
 Device dimensions 
 Functional distance 

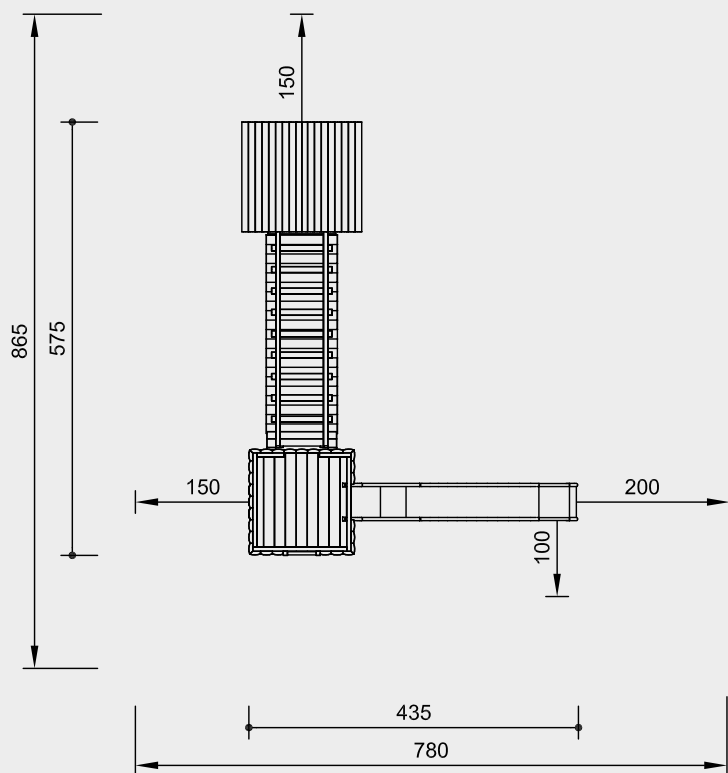

Scale 1:100

Safety check according to DIN EN 1176

Order No. L2.18000
Tower Combination 18 made of larch

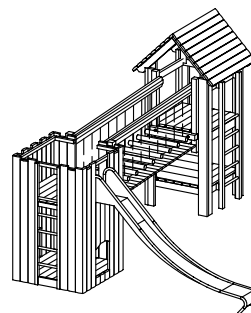

Components

Order No.

1 Platform Hut with roof with steel feet	3.13300
1 Support Frame for Chain Path for Huts	3.66290
1 Walkway for 3.00 m Chain Path	3.66260
1 Square Tower with steel feet	L3.20500
1 Support Frame for Chain Path for Square Towers	3.66240
1 Stainless Steel Slide	3.63020

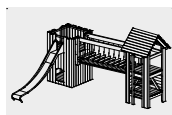

L2.18000